

La Providence – Montpellier

CORRIGE – M. QUET

EXERCICE 1

Associer à chaque pavé droit son patron :

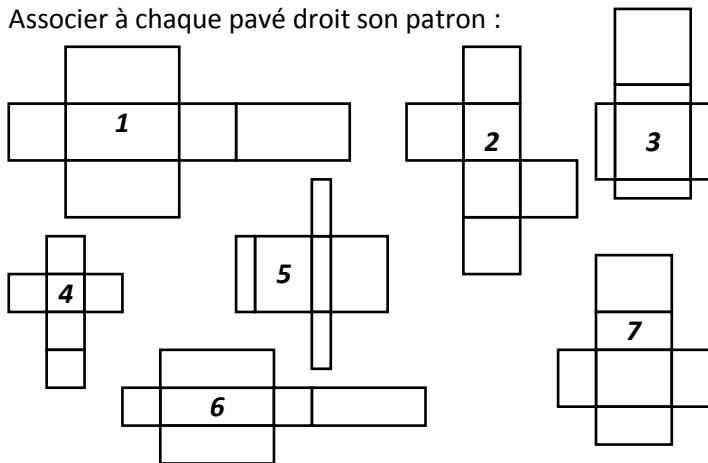

PATRON	1	2	3	4	5	6	7
SOLIDE	<i>b</i>	<i>d</i>	<i>c</i>	<i>g</i>	<i>e</i>	<i>f</i>	<i>a</i>

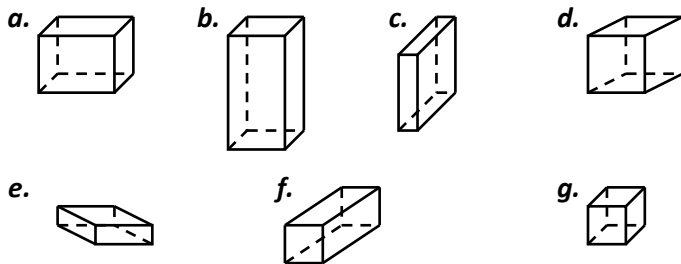

EXERCICE 2

Indiquer les dimensions manquantes :

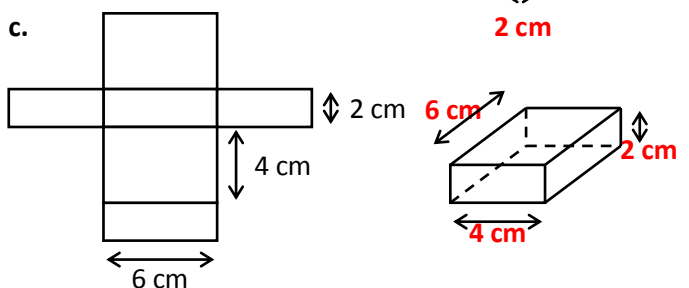
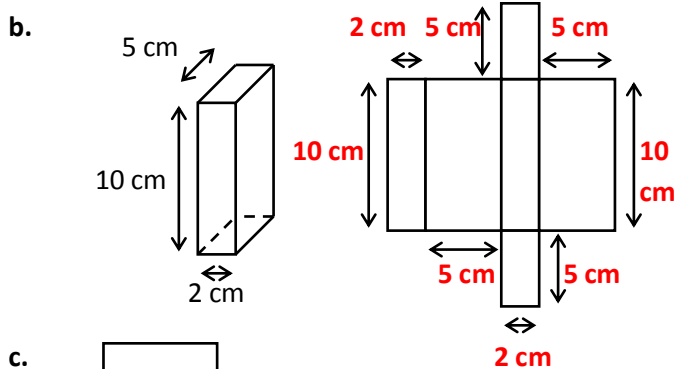
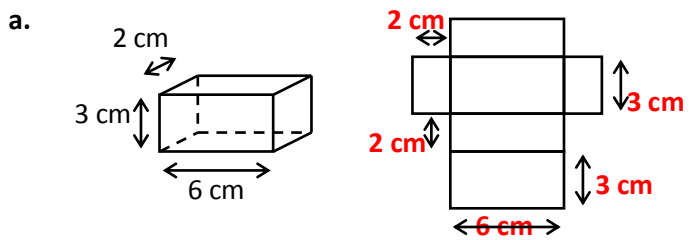

EXERCICE 3

Indiquer les noms des sommets manquants :

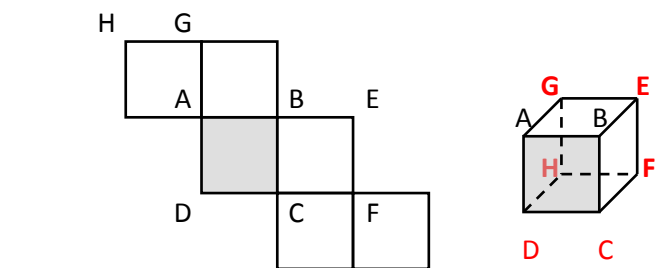
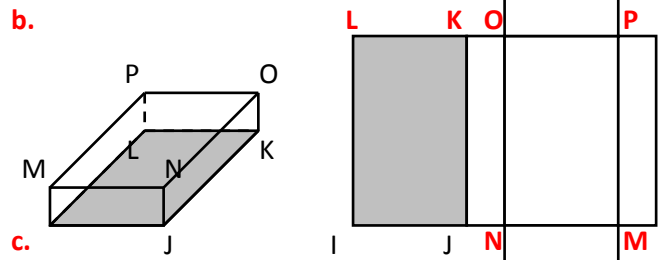
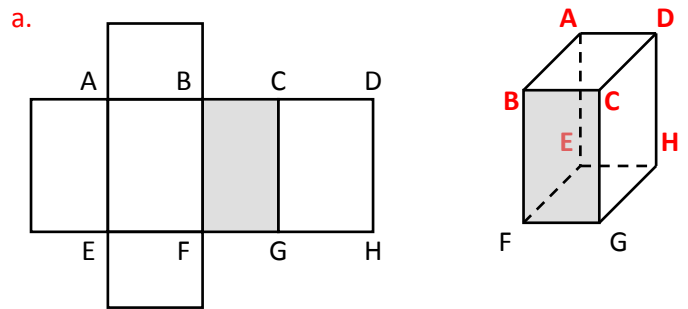

EXERCICE 4

Compléter les dimensions manquantes :

